

70 Cutlass - 442 LED Kit Installation

This 1970 Cutlass - 442 Sequential LED Taillight Kit is used to replace the OEM taillight bulbs with LED lighting panels. The replacement LED panels provide the same functionality of the incandescent bulbs being replaced, i.e. running lights, turn signal, brake signal illumination functions, back up and emergency flash lighting where applicable. The kit also incorporates sequential lighting options. The kit provides an easy installation with minimal time and tools.

Tools Needed:

1. Small flat blade screwdriver
2. Pliers/terminal crimpers
3. Wire cutters
4. Electrical tape
5. 5/16" drill bits
6. Electric drill
7. Heat gun or suitable heat source
8. Tools required to remove taillight housings from vehicle

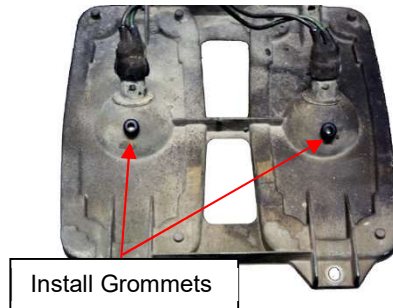

Figure 1

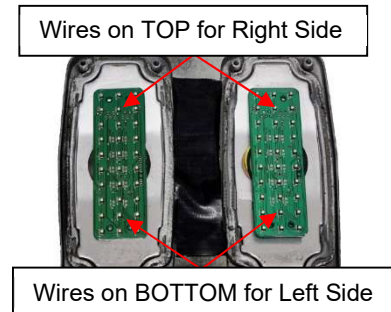

Figure 2

Note: This LED taillight kit requires the installation of a low current turn signal flasher (not included). If you don't already have one, they can be purchased locally at any good auto parts store. Example: NAPA part stores sells them under Part Number EL12L1. Easy Performance Products also offers a 100% solid state flasher module is designed to work best with this LED kit.

Installation:

1. Remove taillight housings from the vehicle and the lenses from the housings.
2. Clean the flat surfaces on the interior flat surfaces of the housing. Note: These surfaces must be clean and dry to assure the best adhesion of the mounting tape that will hold the LED panels in position.
3. Drill 2 – 5/16" holes on the hemispherical surface near the bulb socket connectors. (See Figure 1) The exact location of each hole is not critical. Then install provided rubber grommet into the drilled hole. One method to simplify installation is to pinch grommet, insert protruding edge into the hole, then use a small flat blade screwdriver to push/work the remaining edge through the hole.
4. TAILLIGHT LED PANEL MOUNTING
 - 4.1. **CAUTION:** The LED panels must be installed in proper location for the panels to operate properly. Proper identification and mounting orientation is critical for a successful installation. Panels have the following position identification:

Outboard Panels – Has 1157 bulb base along with 5 loose end wires.

Inboard Panel – Has only 4 loose end wires.

(Note: Outboard = Nearest to fender, Inboard = Towards vehicle center)

ALSO: The LED panels must be orientated differently on the Left Side versus the Right Side. The loose end wires are attached to the LED panels on one end. This end is orientated UP for the Right Side panels and is orientated DOWN for the Left Side panels. (See Figure 2)

- 4.2. For the Outboard light panels, insert the 1157 bulb base into the outboard housing cavity's bulb socket. Then, feed the five wires (Pink, Yellow, Orange, Green & Blue) through the rubber grommet within the housing.
- 4.3. For the Inboard light panels, feed the four wires (Yellow, Orange, Green & Blue) through the rubber grommet within the housing.
- 4.4. For each lighting panel, orientate the panel correctly for the appropriate Left or Right Side.
 - The Right Side housing will have end with the wires attached are on the Top end.
 - The Left Side housing will have end with the wires attached are on the Bottom end.

When orientated correctly, remove the cover tape on the Foam Mounting Tape on the panel ends. Center the panel within the light housing cavity and press firmly into place to adhere the panel to the housing. The results should look like Figure 2.

- 4.5. On each housing, bring each matching color wires (except Pink) together for splicing with moderate slack. Cut off excess wire length and strip off 3/16" insulation off each wire. Slide a piece of heat shrink tubing over all wires on the outboard wires. Using the butt splices provided, insert the one color wire into each side and crimp the wires together. Then slide the heat shrink tubing over splice and shrink into place with a heat gun or other suitable heat source. (See Figure 3)

5. Install the lenses into the housings and the housings back into the vehicle.
6. If sequential lighting patterns are desired, complete all steps in this Section 6. (Refer to Wiring Diagram)
 - 6.1. Strip a ¼" of insulation off each Pink wire coming from each outboard housing to expose copper wire. Crimp a male ¼" blade terminal onto the end of each Pink wire stripped. Perform this operation for both left and right housings.
 - 6.2. Strip a ¼" of insulation off one end of the 20 foot Pink wire included with kit to expose copper wire. Crimp a female ¼" blade terminal onto the end of this Pink wire stripped.
 - 6.3. Connect the female terminal just crimped to one of the male terminals on one side of the vehicle. Route the Pink wire to the other male terminal on other side of vehicle.
 - 6.4. Cut Pink wire routed to second male terminal, strip a ¼" of insulation off on both ends of the 20 foot Pink wire just cut to expose copper wire. Crimp both stripped ends into a female ¼" blade terminal.
 - 6.5. Connect the female terminal just crimped to the other male terminals on second side of the vehicle.
 - 6.6. Route the Pink wire from the rear of the vehicle to either the ignition switch or fuse block. Make the final connection to an appropriate ignition power source. **CAUTION:** The circuit the Pink wire is attached to must be fused with a 10 amp or less fuse, to protect the Pink power wire running to the LED panels. If the circuit being connected to is fused with a fuse greater than 10 amps, install an inline fuse at the Pink wire connection with a 5 to 10 amp fuse.
 - 6.7. Secure all wires with electrical tape.
7. This completes the installation.

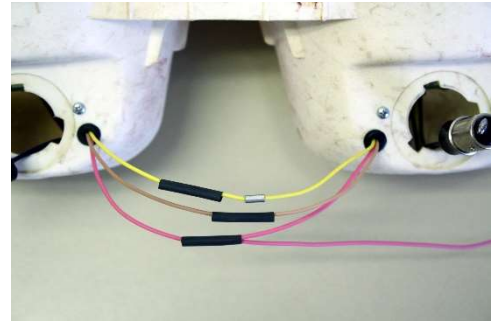

Figure 3

Sequential Lighting Operation:

The Pink wire from each LED Taillight Panel must be connected to ignition power in order for sequential patterns to be activated. If the Pink wire is not connected, the taillight panels will flash with the non-sequential taillight / brake light signal.

The various sequential patterns are defined in the attached Sequential Pattern Chart. The LED Panels will have an Application and Firmware Code identifying the firmware and associated chart the panels were manufactured to. Matching the Application and Firmware Code between the panels and the chart will assure you are using the correct Sequential Pattern Chart for the LED panels being used.

The LED panels can be programmed to flash a variety of sequential patterns. To change the programmed flash sequence, the ignition must be On. To observe the Sequence pattern being selected, the turn signal or flasher signal must be activated. The Sequence pattern is changed by pressing the small pushbutton on the front side of the circuit board. Access to the programming pushbutton is achieved by removing the taillight lens on the respective outboard panel (nearest to fender) and pressing the small pushbutton in the center of the light panel. Pressing the programming pushbutton on the circuit board with a short duration press (i.e. holding down for less than 1 second) will step the panel from one sequence number to the next. If the last sequence in the list is selected and the programming pushbutton is pressed again, it will cycle back to Sequence 1 in the list. Pressing the programming pushbutton with a long press (i.e. holding button down for 1 second or longer) will reset the pattern to default Sequence 1. Once a pattern is selected, that pattern is stored in memory and will be used until another pattern is selected, regardless if the ignition is turn Off.

After pressing the programming button, the panel will flash one half of the panel equal to the sequence number. Example: After pressing the programming button, one half of the panel flashes 5 times, then Sequence 5 is now the currently selected sequence. The other half of the panel will remain unlighted during the sequence flashing process. Lighting up only half of the panel during this sequence number flashing allows the sequence number flashing process to be very distinguishable. If the button is pressed multiple times successively, the panel will step up in the sequence numbers as many times as the button has been pressed. When the programming button is pressed multiple times, the sequence number flash count will occur twice. The second sequence number flash count will be the correct count.

If you have any question, concerns or comments on the 70 Cutlass - 442 LED Kit Installation and/or the product, please visit Easy Performance Products website at www.easypower.com for more information. Otherwise, you can always contact us at: support@easypower.com.

Wiring Diagram:

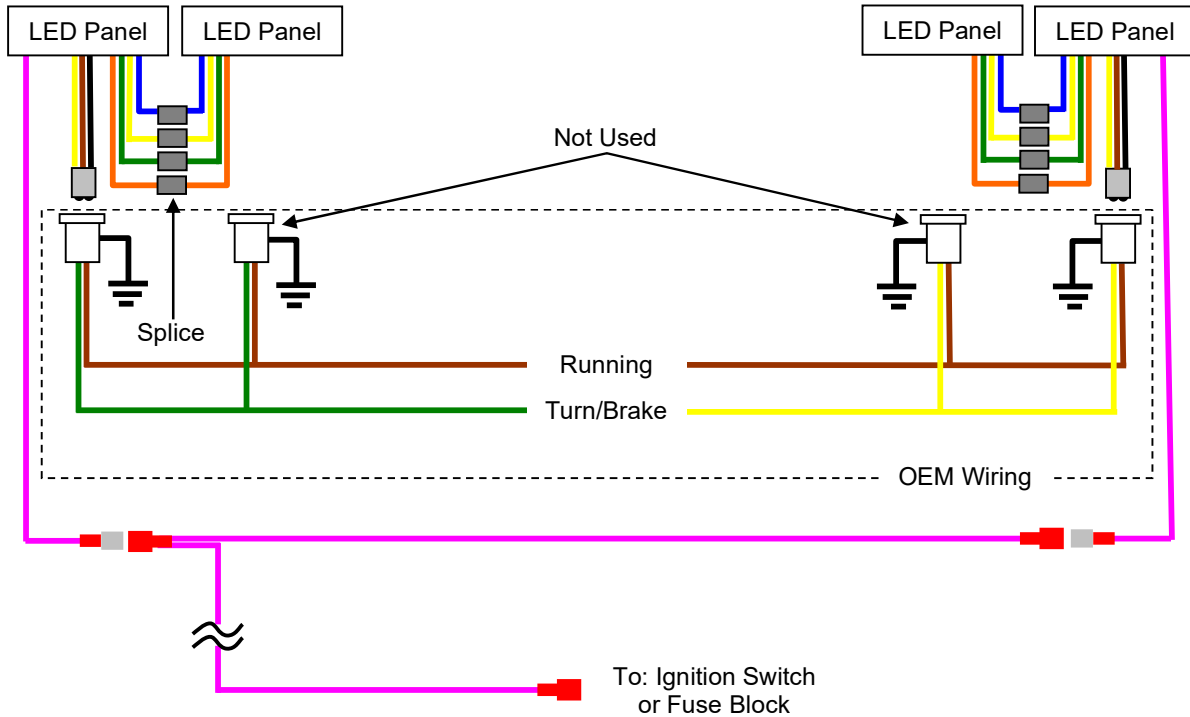

Sequential Pattern Chart:

Application: 1970 Cutlass - 442

Firmware Code: 16070612

Sequence #	Pattern Description
1	Standard flash with relay, all panels flash simultaneously
2	Sequential light up taillight housing Inboard to Out
3	Sequential light up taillight housing Inboard to Out then back
4	Sequential light up taillight housing Inboard to Out then turn Off Inboard to Out
5	Panels flash sequentially, Inboard to Out
6	Panels flash sequentially, Inboard to Out then back
7	Sequential light up, Center of tail housing to Out
8	Sequential light up, Center of tail housing to Out then back
9	Sequential light up, Center of tail housing to Out then turn Off Center to Out
10	Demonstration Mode – Flashes sequence numbers 2 through 9 cyclically, flashes each sequence 6 times before stepping to the next sequence

TROUBLESHOOTING GUIDE

How the taillights are supposed to work:

With the running/driving lights ON, there should be +12.4 volts or more on the Tan wire going to the LED panels on both sides of the vehicle.

With the ignition ON and the Turn Signal activated, running/driving lights OFF and brake NOT applied, there should be pulsing +12.4 volts or more on the Yellow wire going to the LED panel on the vehicle side receiving the turn signal. Also, there should be constant 0 volts on all Yellow wire on the vehicle side that is NOT receiving the turn signal.

When the Brake is applied, running/driving lights OFF and turn signals not activated, there should be constant +12.4 volts or more on the Yellow wires going to the LED panels on both sides of the vehicle.

If equipped with back up lights, when the vehicle is placed into reverse, there should be +12.4 volts or more on the Blue wire going to the LED panels on both sides of the vehicle.

If these voltages are not achieved, then the vehicle's wiring should be inspected and corrected to provide the expected voltage signals.

How to bench test the taillights:

The LED panels can be bench tested with a 12 volt battery that is fully charged (reading 12.6 volts) or near fully charged (reading above 12.4 volts). Red LED bench testing is performed on the 1157 bulb base (one with 3 wires; yellow, tan & black) wired to the LED panels, and if equipped, the White LED bench testing is performed on the 1156 bulb base (one with 2 wires, blue & black) wired to the LED panels. To bench test the panels, use a length of test wire and simply connect the bulb base (silver metal casing) to the negative post on an automotive 12 volt battery. Then use another length of test wire to connect the battery's positive post to one of the solder bump pads on the end of the bulb base. Just follow the diagrams below to perform specific tests on the LED panels.

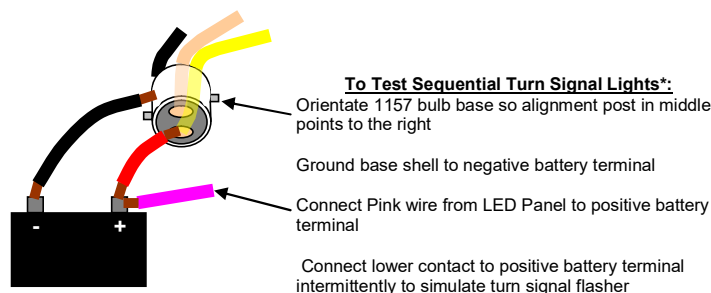
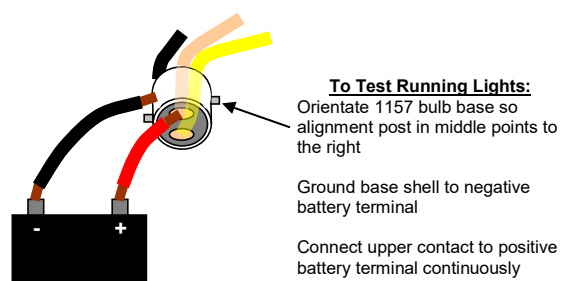
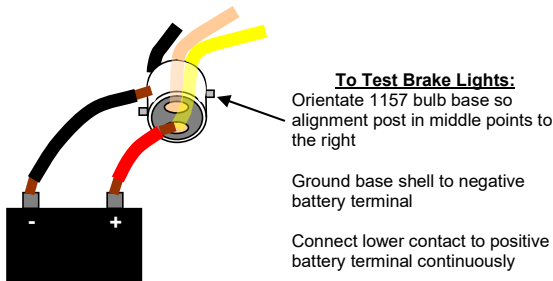
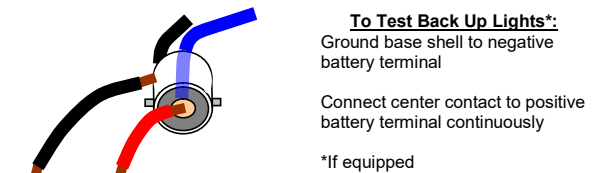
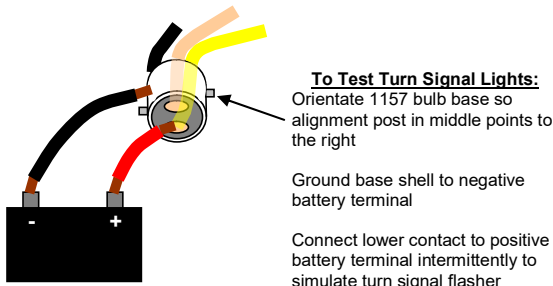

*Note: Panels must be programmed to the same sequential pattern to test sequential effect



70 Cutlass - 442 LED Kit Installation

Running/driving lights are dim:

The most common problem with the running lights being dim is insufficient voltage across the Tan wire and Black wire connections on the LED panels. The voltage drop across these connection points must be 12.4 volts or higher to achieve full brightness of the LED panels while in running light mode. If the voltage across these points is lower than 12.4, then illumination brightness will diminish proportionally and will not illuminate below 11 volts. The first action should be testing the voltage at the battery. The voltage on the battery posts should be above 12.4 volts. If not, then charge or replace the battery so it maintains a voltage above 12.4 volts. If voltage measured between the Tan wire and Black wire connections on the LED panels is below 12.4 volts with proper battery voltage, then running light circuitry and grounding circuitry must be inspected and repaired to provide the required voltage to the LED panels.

Turn signals do not flash when the turn signal is activated:

For most cars, the ignition must be ON to test the turn signal functions. Make sure the ignition is ON and the flasher module is receiving +12 volts to the +12 volt terminal.

For the LED panels to flash a turn signal pattern, the Yellow wire going to the LED panels must receive a pulsating + 12 volt signal, relative to chassis ground. When changing from incandescent bulbs to LED lighting, most vehicles will require changing to a 'Low Current Flasher Module'. The problem with the original OEM type flasher module is the LED panels draw such low current that the OEM flasher sees LED lights as a burned out light bulb and typically do not flash. Changing to a 'Low Current Flasher Module' will remedy this situation.

If a 'Low Current Flasher Module' is already installed, the next step to diagnosing the problem is to test the output of the turn signal flasher. If the turn signal flasher is not producing pulsating + 12 volts on the 'Load' terminal (flasher not activating) when the turn signal is activated, then the flasher module will need to be replaced. If the flasher's 'Load' terminal is producing pulsating +12 volt signal, then the vehicle's wiring must be corrected to permit this pulsating voltage reaching the taillight sockets.

When the turn signal for one side is activated, the opposite side flashes (dimly) as well:

If you are seeing both sides of your car flashing when only one side is supposed to be flashing, then there is cross-talk occurring between your Left and Right turn signal circuits. If you are running incandescent light bulbs in the front turn signal housings, then remove the bulbs from both sides and retest the rear turn signals. If the problem goes away with removing the front bulbs (i.e. the rear LED panels flash turn signals correctly), then you have a grounding problem in your front turn signal housings. Correct grounding connections so you are able to test the resistance between the front bulb socket body (ground) and the negative post on the battery is less than 1 ohm.

The taillights do not light up all (i.e. no running/driving lights, brake lights, turn signals):

If the taillights are not lighting up at all (i.e. with running lights, brake or turn signal), then the most likely reason is they are not receiving a ground connection. Keep in mind that the bulb sockets that the bulb bases plug into must be in contact with the metal back housing to achieve a ground connection. For many classic cars, the taillight housing is metal and the bulb sockets have metal clips/tangs that use the metal housing for making the ground connection. Thus, the bulb socket clip/tang must be making good connection to the housing and the housing must have good metal-to-metal contact with the chassis to establish a good ground connection.

The next likely source of this problem is a connection issue with the bulb base. Please take a piece of Scotch-Brite pad, fine sandpaper or steel wool and clean off the solder bumps on the 1157 bulb bases wired to the LED assembly. When you make the connection, use a voltmeter or Digital Multi Meter to check and make sure you are getting +12 volt (relative to chassis ground) signals to the Yellow wire solder junction from the 1157 bulb base on LED assembly. If you are not getting +12 volt signals (pulsing +12 volts if the turn signal is ON, steady +12 volts if the brake is applied) to the Yellow wire solder junction, then you must determine where the circuit is disconnected.

The same test can be performed for the Running/Driving Lights. For this function, the Tan wire solder junction from the 1157 bulb base on LED assembly should be getting +12 volt (relative to chassis ground) signal when the light switch is pulled out to power up the Running/Driving Lights.

Another possible cause for the panels not to light up at all is the solder bumps on the end of the 1157/1156 bulb bases and/or the spring loaded pads and grounding surround within the bulb sockets are contaminated. This can be corrected by using a Scotch Bright pad and buff these metal surfaces so they are clean and void of any tarnish or corrosion.

Brake lights (LED panels) stay on all the time with no turn signal activated or brake pedal being pressed:

Using a voltmeter or Digital Multi Meter, check the voltage on the Yellow wire going to the LED panels when the turn signal is not being activated and the brake pedal is not being pressed. If there is any voltage higher than 0.5 volts, then you must troubleshoot the reason for voltage leaking onto this circuit. Normally, this circuit should be near or at 0 volts.

NOTE: If the vehicle has an aftermarket cruise control system or alarm system installed, check the wiring of the system to see if has a connection to the brake/brake switch circuit. In most cases, they do and the installation instructions for the system should



70 Cutlass - 442 LED Kit Installation

provide alternative wiring for installation into a vehicle that has LED lighting. The installation of the aftermarket system must be made compatible with LED lighting in order for the LED panels to illuminate when properly signaled to do so.

The taillights come on sporadically without the turn signal being activated or brake pedal being pressed:

Our LED light kits are designed to work with the single brake/turn signal wire as the input for differentiating between brake and turn signal function. Referring to the wiring diagram in the installation instructions, the Yellow wire connecting between the 1157 bulb base and the circuit board carries this signal. The way the LED panel distinguishes between a turn signal and a brake signal is by monitoring the voltage on this Yellow wire input. 0 volts is recognized as the Low State and any voltage above ~1 volt is considered a High State. With no brake or turn signal activated, the voltage on this Yellow wire should be at 0 volts (Low State). If the panel sees the voltage transition to a High State voltage on this input, it starts the sequential pattern. If the voltage remains constant (i.e. stays in the High State), the panel will stay fully lit, illuminating the brake condition. If the voltage on the Yellow wire pulses between Low State and High State, then the panel will continue activating the sequential pattern, thus illuminating the turn signal condition. Both conditions are cancelled when the voltage on the Yellow wire drops to 0 volts (Low State) and remains so for over a ½ second.

If your installation is not able to achieve a turn signal condition, then the Yellow wire is not receiving a pulsed signal between. In other words, the panel is not seeing pulsed transitions between Low State and High State. Because your panel is staying in the brake condition, then this Yellow wire is seeing a High State voltage constantly. You will need to troubleshoot the wiring of the vehicle to determine the reason the signal being supplied to the Yellow wire is not pulsing between 0 volts and high state voltage when the turn signal is activated in the vehicle.

The taillights do not flash sequentially correctly:

For LED kits that have more than one LED circuit board per side, all circuit board panels within the assembly must be set to the same program number for the assembly to function properly. Pressing the programming button for more than 1 second will reset panels to Sequence #1. From there, you can step the sequence number by pressing the programming button. Be sure to observe each panel to ensure all panels are flashing the same sequence number.

The Pink wire from each LED Taillight Panel must be connected to ignition power in order for sequential patterns to be activated. If the Pink wire is not connected, the taillight panels will flash with the non-sequential taillight / brake light signal.

If the taillights work in every respect other than the sequential patterns, then you have likely lost power to the Pink wire going to the LED panels. Check your wiring and any fuses on the circuit supplying +12 volts to the Pink wire.

The taillights have been programmed to the same sequential pattern but they flash out of sync:

For LED kits that have more than one LED circuit board per side, after pressing the programming buttons and the panels have ceased flashing the sequence number, the turn signal must be turned off and then reactivated to have all the panels starting the sequence pattern at the same time. In some cases, power must be removed from the Pink wire (turning ignition Off) in order to get the panels re-initialized and working together.

When the running lights are turned On, the taillights are flashing randomly:

The most likely reason for this type of behavior is one or more of the 1157 bulbs / bulb bases inserted into the 1157 bulb sockets are mis-inserted and causing the running light circuit and turn signal circuit to be shorted together. This mis-insertion can be on any of the front or rear turn signal sockets. Remove and inspect the bulb sockets for damage, improperly aligned contacts inside the sockets as well as inspecting the keying prongs on the bulb bases.

The taillights on either or both sides flash erratically when a turn signal is activated:

This condition can occur when the 1157 bulb base is inserted incorrectly in the taillight bulb socket. The problem lies in the bulb base contacts are shorting the running light terminal and the brake/turn signal terminal together. Inspect the bulb base locating pins and the socket terminals for damage. Also check that the terminal plate holding the terminals in proper orientation is not damaged or mis-located. Correct any problems that are detected.